

## Flexy Compact Bain-marie, one well (4GN) with wheels H=900mm, overshelf with LED lights

ITEM # \_\_\_\_\_

MODEL # \_\_\_\_\_

NAME # \_\_\_\_\_

SIS # \_\_\_\_\_

AIA # \_\_\_\_\_

**322002 (F01H4AW02S)**

 Bain-marie on cupboard,  
 one well (4 GN container  
 capacity) with wheels,  
 overshelf with LED lights and  
 two stainless steel tray  
 sliders, H=900mm (Nordic)

### Short Form Specification

#### Item No.

Compact design, ideal for space saving environments. AISI 304 Foldable tray sliders on long sides. Unit mounted on 125 mm wheels 2 swivel and 2 with brakes. Soft closing doors on operator side. Underneath ambient cupboard with doors. A type AISI 304 overshelf equipped with LED lights designed for extra increased visibility on the surface for charming food display. Sleek, minimalist glass structure, food and dust does not get trapped and easy to clean. Curved glass. Sturdy body construction with laminated panelings on 4 sides. Designed to serve the food in gastronorm containers with a maximum height of 200mm. Electronic overheating protection. Digital control with temperature display with precise adjustment (0,1°C). Fully compliant HACCP digital controls include visible alarms. Designed to work with both hot and cold inlet water. Etched foil heating elements to maximize heat transmission for reduced warm-up times. Well in 304 AISI stainless steel with rounded corners to facilitate cleaning operations. The well is also equipped with a drain hole. Well bottom is inclined to guarantee full well drainage. 19mm thick glass wool isolated with galvanize sheet guarantees excellent well insulation to reduce energy dispersion. Heating elements connected to the well bottom include safety thermostat. Food introduced at the correct temperature maintains its core temperature according to Afnor Standards. 900mm worktop height.

### Main Features

- Electronic overheating protection.
  - Designed to serve the food in gastronorm containers.
  - Suitable for GN 1/1 containers with a maximum height of 200 mm.
  - Precise temperature control and setting at 0,1°C .
  - As standard the product comes with digitally controlled thermostat which is in line of HACCP norms and provides visual alarm as a warning of the increasing or decreasing temperatures.
  - Designed to work with both hot and cold inlet water.
  - It is possible to transform one of the GNs to soup dispenser with the available accessory.
  - Perfect compact design makes it ideal for space saving environments.
  - CB and CE certified by a third party notified body.
  - Soft closing doors on operator side.
  - Underneath ambient cupboard with doors ideal for extra storage.
  - Available options with online configurator: colors, tray sliders, overshelves, feet/wheels with desired diameter, height 750mm for kids.
  - Overshelf equipped with LED lights.
  - Optional plinth can be installed to cover the feet or the wheels.
  - AISI 304 Tray slider in flush mounted stainless steel is installed on long sides and they can also be folded down to facilitate passage of the units through doorways.
  - Ideal for servery lines without an operator.
  - Unit mounted on 125 mm wheels 2 swivel and 2 with brakes.
  - Stylish A type overshelf designed for extra increased visibility on the surface for charming food display.
  - Curved glass.
  - Food introduced at the correct temperature maintains its core temperature according to Afnor Standards.
  - Available dimensions: 2, 3, 4 GN.
  - Automatic refill is available as an option.
  - Thanks to the sleek, minimalist glass structure, food and dust does not get trapped and the cleaning is made easier.
- ### Construction
- Heating elements connected to the well bottom include safety thermostat.
  - Well bottom is inclined to facilitate water drainage.
  - IPx4 water protection.
  - Well in 304 AISI stainless steel with rounded corners to facilitate cleaning operations. The well is also equipped with a drain hole.
  - Electronic control with temperature display.
  - Overshelf in complete AISI 304.
  - Top in AISI 304.

APPROVAL: \_\_\_\_\_



**Electrolux**  
PROFESSIONAL

**Flexy Compact  
Bain-marie, one well (4GN) with wheels  
H=900mm, overshelf with LED lights**

- Sturdy construction with laminated panelings on 4 sides.

**Sustainability**



- 19mm thick rock wool isolated with galvanize sheet guarantees excellent well insulation to reduce energy dispersion.
- Etched foil heating elements to maximize heat transmission for reduced warm-up times.



**Flexy Compact  
Bain-marie, one well (4GN) with wheels H=900mm, overshelf with LED  
lights**  
The company reserves the right to make modifications to the products  
without prior notice. All information correct at time of printing.

2024.12.04

Front

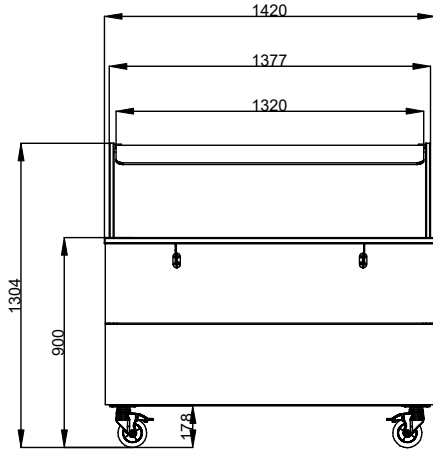

Side

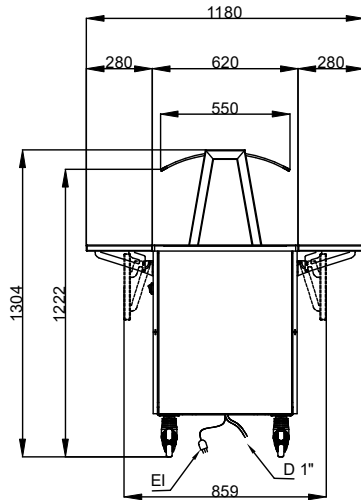

D = Drain  
 EI = Electrical inlet (power)

Top

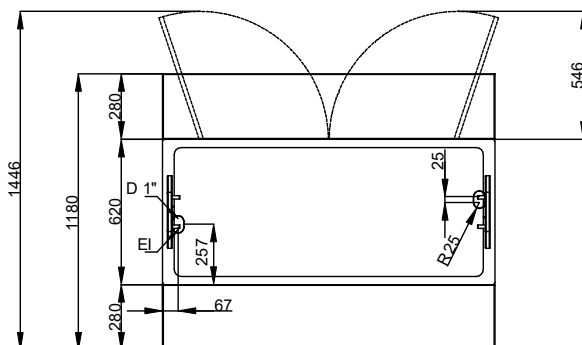

#### Electric

Supply voltage:

322002 (F01H4AW02S) 220-240 V/1N ph/50/60 Hz

Electrical power max.:

3.04 kW

#### Water:

Water drain outlet size:

3/4"

#### Key Information:

N° of doors:

2

External dimensions, Width:

1420 mm

External dimensions, Depth:

1180 mm

External dimensions, Height:

1304 mm

Net weight:

145.5 kg

Shipping height:

1480 mm

Shipping width:

930 mm

Shipping depth:

1480 mm

Shipping volume:

2.04 m<sup>3</sup>

Set temperature:

+85 / +95 °C

#### Sustainability

Noise level:

45 dBA